

**HELI**

www.helichina.com

**HELI**

# CPD15/18/20/25 /30/35/38

GB2LI-H GB2LI-M GB3LI-S GE3LI-S  
GB6LI-H GB3LI-M GB6LI-S GE6LI-S



**LIION** **1.5-3.8 t**  
G2 Series Lithium-ion Battery  
Forklift Truck



**ANHUI HELI CO., LTD.**

Add / No.668, FangXing Road, Hefei, China

Fax / +86-551-63639966

Tel / +86-551-63639068(America); 63639258(Europe); 63639358(Asia);  
63662105(Africa & Middle East); 63639530(Overseas Marketing)



LinkedIn



YouTube



Facebook

Design&PrintForklift Printing 20220215

\* Our products are subject to improvements and changes without notice.



HELI

Fearless of Any Rough Application,  
**HELI New Series Lithium Forklift,**  
Your Best Choice





## Powerful Performance, High Efficiency

Customers can freely choose from the 3 different configurations: S, M, H. Especially M and H configurations are comparable with internal combustion trucks in terms of comprehensive performance.

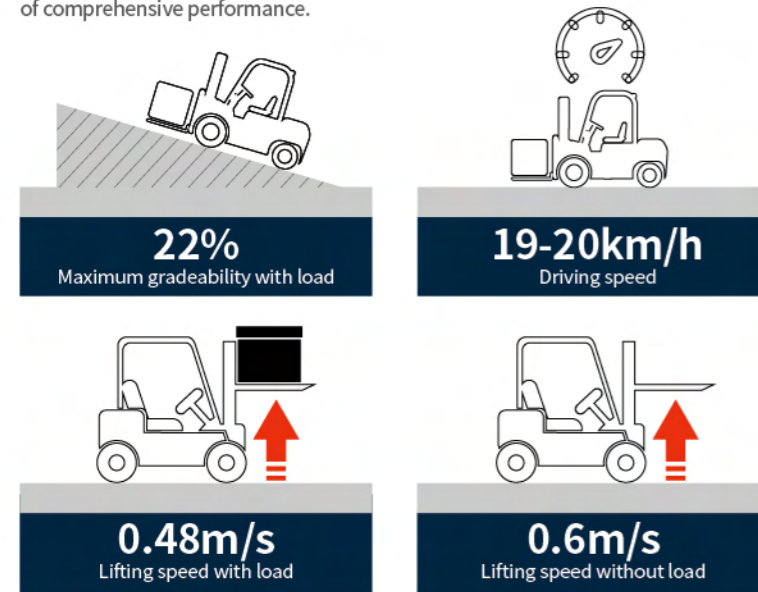

Note: the data displayed are all based on the model CPD30-GB2LI-H, and data for other trucks are shown in the table of technical parameters.

## Smart and Safe, Ease In All Aspects

- Steering deceleration: Auto steering deceleration reduces the risk of turning over;
- Steering started by steering wheel: the steering wheel can directly start the steering function and provides the required oil quantity according to the steering wheel speed;
- Color screen instrument: Bilingual (CN/EN) options, full vehicle information at a glance;
- PES Three-speed mode: Choose multiple speed modes according to working conditions, guarantee work efficiency;
- Rear handle with horn switch for safer reversing;
- Lithium battery is automatically heated at low temperature, with excellent low temperature adaptability.

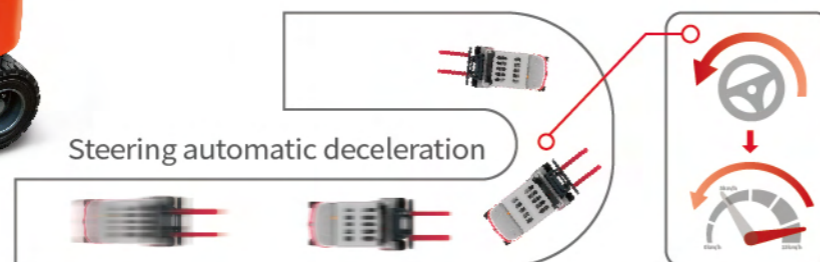

## Optimized Ergonomic Design, Better Driving Comfort



Large boarding space and foot operation space for more comfortable operation



New type of ratchet hand brake reduces operating force by 17%.



Brake fluid within reach, easy to check and refill

- Optimized mast and pressed overhead guard for improved visibility and safety.
- Ultra-low torque steering gear and lighter steering operation reduces driving fatigue.



USB power supply design is more thoughtful



IC truck type control valve stem, better fit to the driver's habits



坡度20%

## High Quality & High Reliability

The integrated cast drive axle and reinforced cast steering axle have been proven in the market and are mature and reliable. The mast force optimization design improves the overall performance and effectively ensures the operation safety.



## Tested in Rough Operating Environment



IPX4 waterproof: the vehicle is powered on to simulate a 15min short-time 5000L rainstorm test, and the vehicle can continue to run without failures.



After 10mins wading test, the vehicle has no failure. (Water depth 200mm)



The whole vehicle can be operated alternately in -20°C cold storage for 6 hours and parked in the cold storage for 12 hours without any failure and can continue to work.



The truck passed simulation experiment of bumpy road.

## Centralized Checkpoints, Easy Maintenance

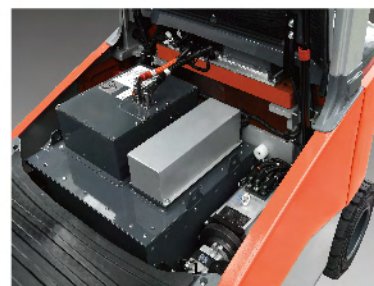

The electrical design is concentrated on the top of lithium battery, and the maintenance points are centralized, which is convenient for inspection and maintenance.

## Operating Cost Comparison: Lithium battery forklift **vs.** Lead-acid battery forklift **vs.** IC forklift

The advantages of HELI lithium battery forklift trucks are more prominent in the life cycle cost.

Compared with internal combustion forklift truck, lithium battery forklift truck has the advantages of no noise, no pollution, small vibration and simple operation.

Compared with the lead-acid battery forklift truck, lithium battery forklift has the characteristics of fast charging and charging at any time, which is more suitable for multi shift operation.

Besides, HELI lithium battery forklift is maintenance free, high power conversion efficiency, and economical overall operation cost.

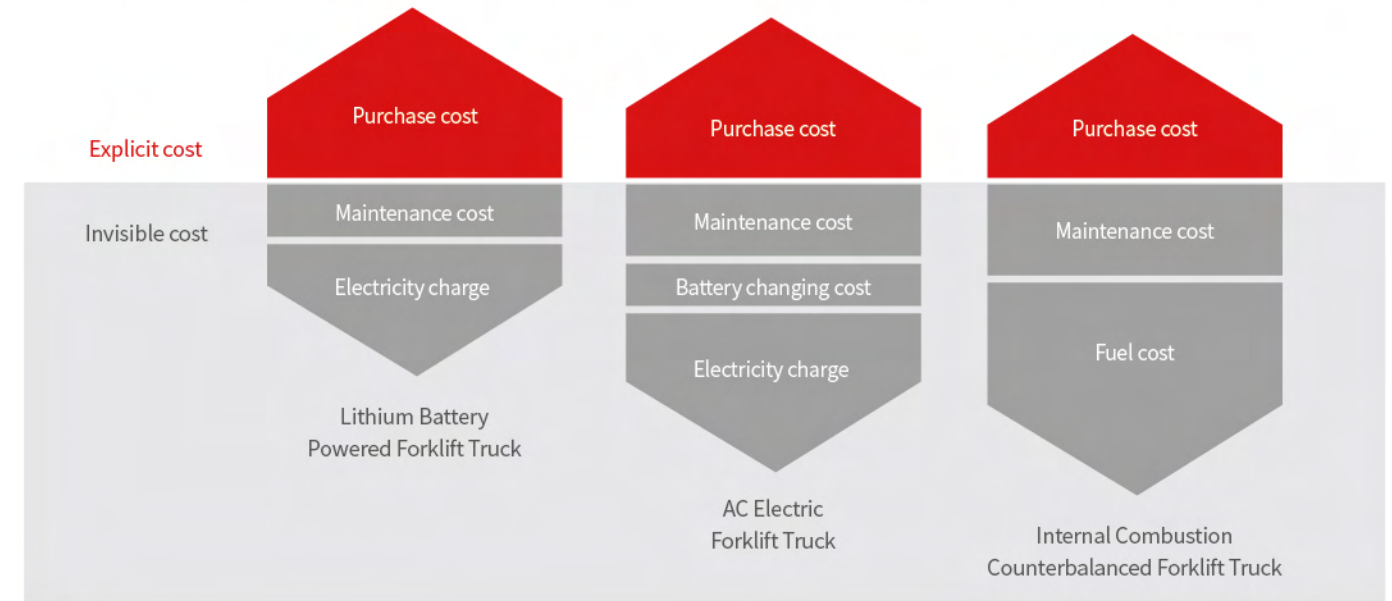

### Lithium Battery Advantages

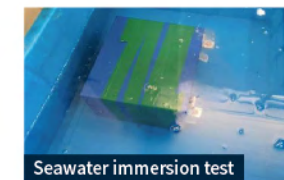

Seawater immersion test



Extrusion test



Heating test



Temperature cycling test

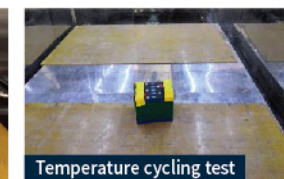

Temperature cycling test



Drop test

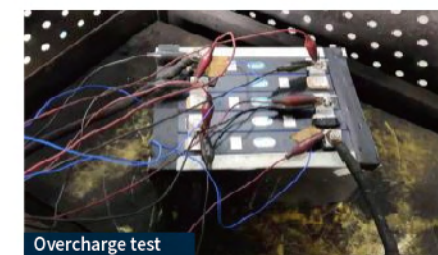

Overcharge test

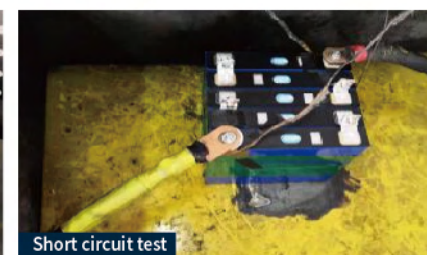

Short circuit test

- The truck selects mature and economical square iron phosphate lithium battery core and module used by large numbers of commercial vehicles; The module adopts aluminum alloy plate frame, which is firm, light in weight and has good heat dissipation effect;
- Fast charging: fast charging makes truck gapless operation possible, and it can be filled in 2 hours;
- High efficiency and safety: The charging and discharging efficiency is up to 98%, and temperature of thermal runaway is over 600 °C;
- Low temperature adaptability: Standard configuration of heating function ensures normal operation of low temperature environment;
- Long service life: the normal charging and discharging cycles is more than 3000 times or 5 years, and capacity retention rate is more than 75%;
- Maintenance free: the battery does not need manual maintenance and does not need to add distilled water electrolyte;
- Green and clean: no pollution and zero emission.



Manufacturer and Technical Data(Tabulation1)									
Characteristics									
1.01	Manufacturer								
1.02	Model		CPD15	CPD18	CPD15	CPD18	CPD15	CPD18	CPD20
1.03	Configuration number		GB2LI-H/GB6LI-H	GB2LI-H/GB6LI-H	GB2LI-M/GB3LI-M	GB2LI-M/GB3LI-M	GB3LI-S/GB6LI-S	GB3LI-S/GB6LI-S	GE3LI-S/GE6LI-S
1.04	Rated capacity	Q	kg	1500	1800	1500	1800	1500	2000
1.05	Load center distance	c	mm	500	500	500	500	500	500
1.06	Power mode			Lithium battery	Lithium battery	Lithium battery	Lithium battery	Lithium battery	Lithium battery
1.07	Driving mode			Seated	Seated	Seated	Seated	Seated	Seated
1.08	Front overhang	x	mm	409	409	409	409	409	414
1.09	Wheelbase	y	mm	1410	1410	1410	1410	1410	1410
Weight									
2.01	Total weight (with/without battery)		kg	2950/2720	3180/2950	2950/2720	3180/2950	2950/2720	3280/3050
2.02	Axle load (laden,front/rear)		kg	3810/640	4290/690	3810/640	4290/690	3810/640	4650/630
2.03	Axle load (unladen,front/rear)		kg	1340/1610	1330/1850	1340/1610	1330/1850	1340/1610	1360/1920
Tyres									
3.01	Tyre type			Pneumatic tyre	Pneumatic tyre	Pneumatic tyre	Pneumatic tyre	Pneumatic tyre	Pneumatic tyre
3.02	Tyre size,front			6.5-10-12PR	6.5-10-12PR	6.5-10-12PR	6.5-10-12PR	6.5-10-12PR	6.5-10-12PR
3.03	Tyre size,rear			16×6-8-10PR	16×6-8-10PR	16×6-8-10PR	16×6-8-10PR	16×6-8-10PR	16×6-8-10PR
3.04	Wheels,number front/rear (x=driven wheels)			2/2	2/2	2/2	2/2	2/2	2/2
3.05	Tread, front	b10	mm	930	930	930	930	930	930
3.06	Tread, rear	b11	mm	920	920	920	920	920	920
Dimensions									
4.01	Mast tilt angle (forward/backward)	α/β	°	6/10	6/10	6/10	6/10	6/10	6/10
4.02	Height (mast lowered)	h1	mm	1995	1995	1995	1995	1995	1995
4.03	Free lifting height	h2	mm	155	155	155	155	155	155
4.04	Lifting height (standard)	h3	mm	3000	3000	3000	3000	3000	3000
4.05	Max. height,extended (with backrest)	h4	mm	4014	4014	4014	4014	4014	4014
4.06	Height of overhead guard	h6	mm	2140	2140	2140	2140	2140	2140
4.07	Seat height relating to SIP (to ground)	h7	mm	1110	1110	1110	1110	1110	1110
4.08	Towing coupling height	h10	mm	260	260	260	260	260	260
4.09	Overall length (with fork)	l1	mm	3060	3060	3060	3060	3060	3060
4.10	Overall length (without fork)	l2	mm	2140	2140	2140	2140	2140	2140
4.11	Overall width	b1	mm	1120	1120	1120	1120	1120	1120
4.12	Fork size:thickness x width x length	s/e/l	mm	35×100×920	35×100×920	35×100×920	35×100×920	35×100×920	40×100×920
4.13	Fork carriage,according to ISO2328			2A	2A	2A	2A	2A	2A
4.14	Distance across fork-arms, Max./Min.	b5	mm	960/200	960/200	960/200	960/200	960/200	960/200
4.15	Ground clearance (at mast)	m1	mm	110	110	110	110	110	110
4.16	Ground clearance (center of wheelbase)	m2	mm	120	120	120	120	120	120
4.17	Right angle stacking aisle width for pallet 1000x1200mm crossways	Ast	mm	3469	3469	3469	3469	3469	3469
4.18	Right angle stacking aisle width for pallet 800x1200mm lengthways	Ast	mm	3669	3669	3669	3669	3669	3669
4.19	Min. outside turning radius	Wa	mm	1860	1860	1860	1860	1860	1860
Performance data									
5.01	Travel speed (laden/unladen)		km/h	19/20	19/20	17/18	17/18	14/15	14/15
5.02	Lift speed (laden/unladen)		m/s	0.54/0.6	0.5/0.6	0.48/0.6	0.44/0.6	0.37/0.5	0.31/0.5
5.03	Lowering speed (laden/unladen)		m/s	0.47/0.5	0.47/0.5	0.47/0.5	0.47/0.5	0.47/0.5	0.47/0.5
5.04	Max.drawbar pull (laden)		N	14000	14000	12800	12800	10000	10000
5.05	Max.gradeability (laden/unladen)		%	25/22	22/20	22/20	20/20	17/20	15/20
5.06	Acceleration time(10 m)(laden/unladen)		s	5.0/4.5	5.0/4.5	5.0/4.5	5.0/4.5	5.5/5.0	5.5/5.0
Battery									
6.01	Battery voltage/Capacity		V/Ah	80/202	80/202	80/202	80/202	80/150	80/150
6.02	Battery weight		kg	230	230	230	230	230	230
Motor and controller									
7.01	Driving motor powering (S2-60min)		kW	10	10	9.5	9.5	8	8
7.02	Lifting motor powering (S3-15%)		kW	18	18	16.5	16.5	10.6	10.6
7.03	Driving motor controlling mode			MOSFET/AC	MOSFET/AC	MOSFET/AC	MOSFET/AC	MOSFET/AC	MOSFET/AC
7.04	Lifting motor controlling mode			MOSFET/AC	MOSFET/AC	MOSFET/AC	MOSFET/AC	MOSFET/AC	MOSFET/AC
Addition data									
8.01	Service brake/Parking brake			Hydraulic/Mechanical	Hydraulic/Mechanical	Hydraulic/Mechanical	Hydraulic/Mechanical	Hydraulic/Mechanical	Hydraulic/Mechanical
8.02	Operating pressure for attachments		Mpa	21.5	21.5	21.5	21.5	21.5	22.5

Note:

(1) In the configuration number, 2 refers to ZAPI controller, 3 refers to Inmotion controller, 6 refers to HELI technology controller.

(2) h7 is the value for standard configuration. For He'an suspension seat, h7 is 30mm increased; for Grammer's suspension seat, h7 is 60mm increased

Manufacturer and Technical Data(Tabulation2)									
Characteristics									
1.01	Manufacturer								
1.02	Model			CPD20	CPD25	CPD20	CPD25	CPD20	CPD25
1.03	Configuration number			GB2LI-H/GB6LI-H	GB2LI-H/GB6LI-H	GB2LI-M/GB3LI-M	GB2LI-M/GB3LI-M	GB3LI-S/GB6LI-S	GB3LI-S/GB6LI-S
1.04	Rated capacity	Q	kg	2000	2500	2000	2500	2000	2500
1.05	Load center distance	c	mm	500	500	500	500	500	500
1.06	Power mode			Lithium battery	Lithium battery	Lithium battery	Lithium battery	Lithium battery	Lithium battery
1.07	Driving mode			Seated	Seated	Seated	Seated	Seated	Seated
1.08	Front overhang	x	mm	460	460	460	460	460	460
1.09	Wheelbase	y	mm	1650	1650	1650	1650	1650	1650
Weight									
2.01	Total weight (with/without battery)		kg	3570/3350	3960/3740	3570/3350	3960/3740	3570/3350	3960/3740
2.02	Axle load (laden,front/rear)		kg	4960/610	5750/710	4960/610	5750/710	4960/610	5750/710
2.03	Axle load (unladen,front/rear)		kg	1760/1820	1800/2160	1760/1820	1800/2160	1760/1820	1800/2160
Tyres									
3.01	Tyre type			Pneumatic tyre	Pneumatic tyre	Pneumatic tyre	Pneumatic tyre	Pneumatic tyre	Pneumatic tyre
3.02	Tyre size,front			7.00-12-14PR	7.00-12-14PR	7.00-12-14PR	7.00-12-14PR	7.00-12-14PR	7.00-12-14PR
3.03	Tyre size,rear			18×7-8-14PR	18×7-8-14PR	18×7-8-14PR	18×7-8-14PR	18×7-8-14PR	18×7-8-14PR
3.04	Wheels,number front/rear (x=driven wheels)			2/2	2/2	2/2	2/2	2/2	2/2
3.05	Tread, front	b10	mm	970	970	970	970	970	970
3.06	Tread, rear	b11	mm	960	960	960	960	960	960
Dimensions									
4.01	Mast tilt angle (forward/backward)	α/β	°	6/12	6/12	6/12	6/12	6/12	6/12
4.02	Height (mast lowered)	h1	mm	2000	2000	2000	2000	2000	2000
4.03	Free lifting height	h2	mm	150	150	150	150	150	150
4.04	Lifting height (standard)	h3	mm	3000	3000	3000	3000	3000	3000
4.05	Max. height,extended (with backrest)	h4	mm	4030	4030	4030	4030	4030	4030
4.06	Height of overhead guard	h6	mm	2170	2170	2170	2170	2170	2170
4.07	Seat height relating to SIP (to ground)	h7	mm	1140	1140	1140	1140	1140	1140
4.08	Towing coupling height	h10	mm	290	290	290	290	290	290
4.09	Overall length (with fork)	l1	mm	3352	3502	3352	3502	3352	3502
4.10	Overall length (without fork)	l2	mm	2432	2432	2432	2432	2432	2432
4.11	Overall width	b1	mm	1160	1160	1160	1160	1160	1160
4.12	Fork size:thickness x width x length	s/e/l	mm	40×122×920	40×122×1070	40×122×920	40×122×1070	40×122×920	40×122×1070
4.13	Fork carriage,according to ISO2328			2A	2A	2A	2A	2A	2A
4.14	Distance across fork-arms, Max./Min.	b5	mm	1030/250	1030/250	1030/250	1030/250	1030/250	1030/250
4.15	Ground clearance (at mast)	m1	mm	115	115	115	115	115	115
4.16	Ground clearance (center of wheelbase)	m2	mm	130	130	130	130	130	130
4.17	Right angle stacking aisle width for pallet 1000x1200mm crossways	Ast	mm	3710	3710	3710	3710	3710	3710
4.18	Right angle stacking aisle width for pallet 800x1200mm lengthways	Ast	mm	3910	3910	3910	3910	3910	3910
4.19	Min. outside turning radius	Wa	mm	2070	2070	2070	2070	2070	2070
Performance Data									
5.01	Travel speed (laden/unladen)		km/h	19/20	19/20	18/19	18/19	14/15	14/15
5.02	Lift speed (laden/unladen)		m/s	0.49/0.6	0.47/0.6	0.46/0.56	0.44/0.56	0.38/0.49	0.35/0.49
5.03	Lowering speed (laden/unladen)		m/s	0.47/0.5	0.47/0.5	0.47/0.5	0.47/0.5	0.47/0.5	0.47/0.5
5.04	Max.drawbar pull (laden)		N	22500	22500	19000	19000	16500	16500
5.05	Max.gradeability (laden/unladen)		%	25/28	24/28	22/28	20/28	18/25	16/25
5.06	Acceleration time(10 m)(laden/unladen)		s	5.5/4.8	5.8/5.1	5.8/5.1	6.0/5.3	6.0/5.3	6.4/5.6
Battery									
6.01	Battery voltage/Capacity		V/Ah	80/271	80/271	80/271	80/271	80/202	80/202
6.02	Battery weight		kg	220	220	220	220	220	220
Motor and controller									
7.01	Driving motor powering (S2-60min)		kW	17	17	16.6	16.6	15	15
7.02	Lifting motor powering (S3-15%)		kW	26	26	25.5	25.5	21	21
7.03	Driving motor controlling mode			MOSFET/AC	MOSFET/AC	MOSFET/AC	MOSFET/AC	MOSFET/AC	MOSFET/AC
7.04	Lifting motor controlling mode			MOSFET/AC	MOSFET/AC	MOSFET/AC	MOSFET/AC	MOSFET/AC	MOSFET/AC
Addition data									
8.01	Service brake/Parking brake			Hydraulic/Mechanical	Hydraulic/Mechanical	Hydraulic/Mechanical	Hydraulic/Mechanical	Hydraulic/Mechanical	Hydraulic/Mechanical
8.02	Operating pressure for attachments		Mpa	21.5	21.5	21.5	21.5	21.5	21.5

Note:

(1) In the configuration number, 2 refers to ZAPI controller, 3 refers to Inmotion controller, 6 refers to HELI technology controller.

(2) h7 is the value for standard configuration. For He'an suspension seat, h7 is 30mm increased; for Grammer's suspension seat, h7 is 60mm increased



Manufacturer and Technical Data (Tabulation 3)										
Characteristics										
1.01	Manufacturer									
1.02	Model		CPD30	CPD35	CPD30	CPD35	CPD30	CPD35	CPD38	CPD38
1.03	Configuration number		GB2LI-H/GB6LI-H	GB2LI-H/GB6LI-H	GB2LI-M/GB3LI-M	GB2LI-M/GB3LI-M	GB3LI-S/GB6LI-S	GB3LI-S/GB6LI-S	GB2LI-M/GB3LI-M	GB3LI-S/GB6LI-S
1.04	Rated capacity	Q	kg	3000	3500	3000	3500	3000	3500	3800
1.05	Load center distance	c	mm	500	500	500	500	500	500	500
1.06	Power mode			Lithium battery	Lithium battery	Lithium battery	Lithium battery	Lithium battery	Lithium battery	Lithium battery
1.07	Driving mode			Seated	Seated	Seated	Seated	Seated	Seated	Seated
1.08	Front overhang	x	mm	477	482	477	482	477	482	482
1.09	Wheelbase	y	mm	1750	1750	1750	1750	1750	1780	1780
Weight										
2.01	Total weight (with/without battery)		kg	4580/4230	5000/4650	4580/4230	5000/4650	4580/4230	5000/4650	5300/4950
2.02	Axle load (laden, front/rear)		kg	6730/850	7580/920	6730/850	7580/920	6730/850	7580/920	8128/972
2.03	Axle load (unladen, front/rear)		kg	2050/2530	2112/2888	2050/2530	2112/2888	2050/2530	2112/2888	2228/3072
Tyres										
3.01	Tyre type			Solid/Pneumatic tyre	Solid tyre	Solid/Pneumatic tyre	Solid tyre	Solid/Pneumatic tyre	Solid tyre	Solid tyre
3.02	Tyre size, front			28×9-15-14PR	28×9-15	28×9-15-14PR	28×9-15	28×9-15-14PR	28×9-15	28×12.5-15-24PR
3.03	Tyre size, rear			200/50-10	200/50-10	200/50-10	200/50-10	200/50-10	200/50-10	200/50-10
3.04	Wheels, number front/rear (x=driven wheels)			2/2	2/2	2/2	2/2	2/2	2/2	2/2
3.05	Tread, front	b10	mm	1000	1000	1000	1000	1000	1080	1080
3.06	Tread, rear	b11	mm	970	970	970	970	970	970	970
Dimensions										
4.01	Mast tilt angle (forward/backward)	α/β	°	6/12	6/12	6/12	6/12	6/12	6/12	6/12
4.02	Height (mast lowered)	h1	mm	2070	2120	2070	2120	2070	2120	2180
4.03	Free lifting height	h2	mm	155	160	155	160	155	160	160
4.04	Lifting height (standard)	h3	mm	3000	3000	3000	3000	3000	3000	3000
4.05	Max. height, extended (with backrest)	h4	mm	4217	4217	4217	4217	4217	4217	4217
4.06	Height of overhead guard	h6	mm	2180	2180	2180	2180	2180	2180	2180
4.07	Seat height relating to SIP (to ground)	h7	mm	1150	1150	1150	1150	1150	1150	1150
4.08	Towing coupling height	h10	mm	320	320	320	320	320	320	320
4.09	Overall length (with fork)	l1	mm	3639	3644	3639	3644	3639	3644	3692
4.10	Overall length (without fork)	l2	mm	2569	2574	2569	2574	2569	2574	2622
4.11	Overall width	b1	mm	1225	1225	1225	1225	1225	1225	1392
4.12	Fork size: thickness x width x length	s/e/l	mm	45×125×1070	50×125×1070	45×125×1070	50×125×1070	45×125×1070	50×125×1070	50×125×1070
4.13	Fork carriage, according to ISO2328			3A	3A	3A	3A	3A	3A	3A
4.14	Distance across fork-arms, Max./Min.	b5	mm	1060/250	1060/250	1060/250	1060/250	1060/250	1060/250	1060/250
4.15	Ground clearance (at mast)	m1	mm	130	130	130	130	130	130	130
4.16	Ground clearance (center of wheelbase)	m2	mm	140	140	140	140	140	140	140
4.17	Right angle stacking aisle width for pallet 1000x1200mm crossways	Ast	mm	3892	3897	3892	3897	3892	3897	3932
4.18	Right angle stacking aisle width for pallet 800x1200mm lengthways	Ast	mm	4092	4097	4092	4097	4092	4097	4132
4.19	Min. outside turning radius	Wa	mm	2215	2215	2215	2215	2215	2215	2250
Performance data										
5.01	Travel speed (laden/unladen)		km/h	19/20	19/20	18/19	18/19	14/15	14/15	17/18
5.02	Lift speed (laden/unladen)		m/s	0.48/0.6	0.44/0.54	0.41/0.54	0.39/0.54	0.37/0.49	0.34/0.45	0.39/0.51
5.03	Lowering speed (laden/unladen)		m/s	0.47/0.5	0.47/0.5	0.47/0.5	0.47/0.5	0.47/0.5	0.47/0.5	0.47/0.5
5.04	Max. drawbar pull (laden)		N	23500	23500	21500	21500	17500	17500	21500
5.05	Max. gradeability (laden/unladen)		%	22/28	20/28	20/28	18/28	16/25	15/25	17/25
5.06	Acceleration time (10 m) (laden/unladen)		s	5.5/4.8	5.8/5.1	5.8/5.1	6.0/5.3	6.0/5.3	6.4/5.6	5.7/5
Battery										
6.01	Battery voltage/Capacity		V/Ah	80/404	80/404	80/404	80/404	80/272	80/272	80/346
6.02	Battery weight		kg	350	350	350	350	350	350	350
Motor and controller										
7.01	Driving motor powering (S2-60min)		kW	17	17	16.6	16.6	15	15	17
7.02	Lifting motor powering (S3-15%)		kW	26	26	25.5	25.5	21	21	26
7.03	Driving motor controlling mode			MOSFET/AC	MOSFET/AC	MOSFET/AC	MOSFET/AC	MOSFET/AC	MOSFET/AC	MOSFET/AC
7.04	Lifting motor controlling mode			MOSFET/AC	MOSFET/AC	MOSFET/AC	MOSFET/AC	MOSFET/AC	MOSFET/AC	MOSFET/AC
Addition data										
8.01	Service brake/Parking brake			Hydraulic/Mechanical	Hydraulic/Mechanical	Hydraulic/Mechanical	Hydraulic/Mechanical	Hydraulic/Mechanical	Hydraulic/Mechanical	Hydraulic/Mechanical
8.02	Operating pressure for attachments		Mpa	21.5	21.5	21.5	21.5	21.5	21.5	22.5

Note:

(1) In the configuration number, 2 refers to ZAPI controller, 3 refers to Inmotion controller, 6 refers to HELI technology controller.

(2) h7 is the value for standard configuration. For He'an suspension seat, h7 is 30mm increased; for Grammer's suspension seat, h7 is 60mm increased

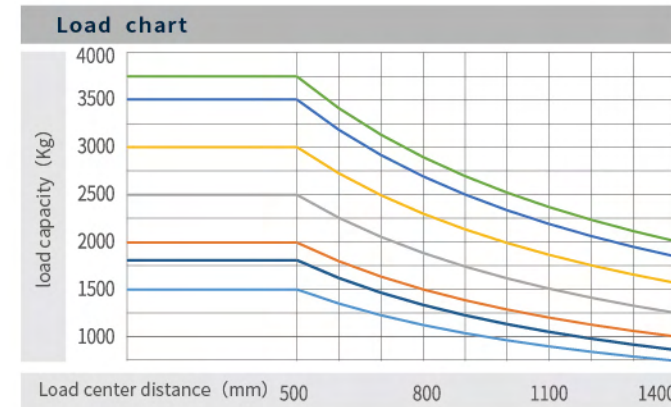
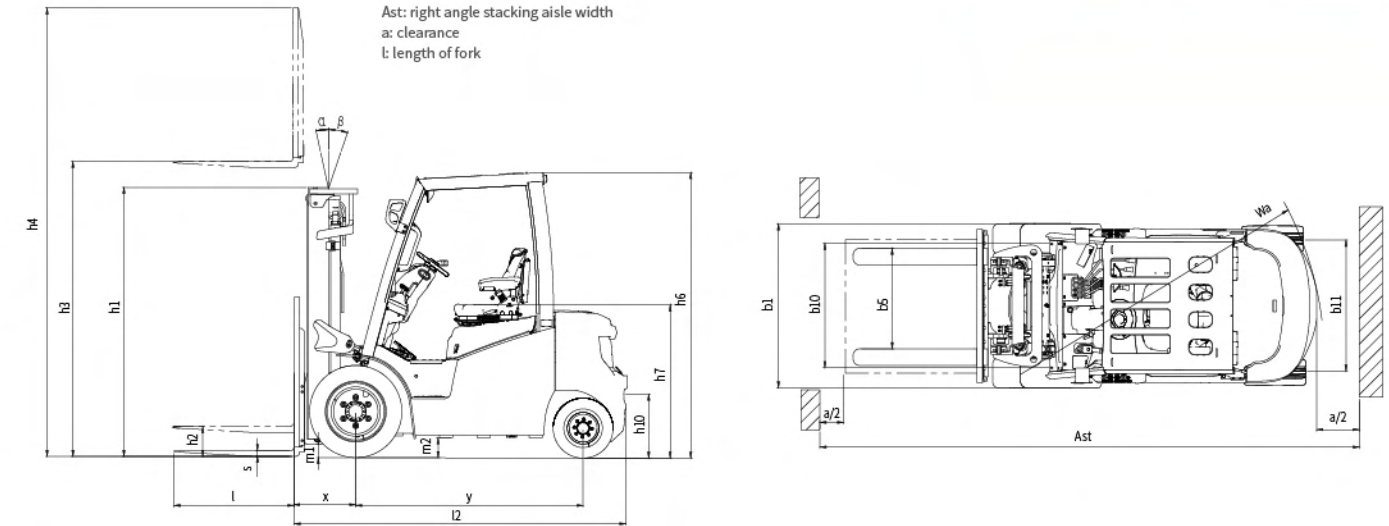

— 1.5t — 1.8t — 2.0t — 2.5t  
— 3.0t — 3.5t — 3.8t

NOTE:

Vertical axle stands for load capacity while horizontal axle stands for load center. Load center is the distance counted from the front of the fork. The base point of the standard load is the center point of the cubic with the same 1000mm dimension in length, width and height. The load capacity should be down, if mast tilts forward, using non-standard forks or loading goods with extra width. Please notice the different load capacity between different load centers according to load chart.

Color Options (the color of truck body can be customized)			
Model	Standard configuration	Selective assembly1	Selective assembly2
H			
M			
S			

Note: The color of the appearance of model CPD15/18/20/25/30/35-GB6LI-H is the same with that of model M and S.



Wide View Standard Mast (Tabulation1)

Mast model	Max. lifting height(mm)	Load capacity (lode center 500mm)(kg)								Height (mast lowered)(mm)						
		1.5t	1.8t	2t(E)	2t	2.5t	3t	3.5t	3.8t	1.5-1.8t	2t(E)	2t	2.5t	3t	3.5t	3.8t
M200	2000	1500	1800	2000	2000	2500	3000	3500	3800	1495	1495	1500	1500	1570	1620	1680
M250	2500	1500	1800	2000	2000	2500	3000	3500	3800	1745	1745	1750	1750	1820	1870	1930
M300	3000	1500	1800	2000	2000	2500	3000	3500	3800	1995	1995	2000	2000	2070	2120	2180
M330	3300	1500	1800	2000	2000	2500	3000	3500	3800	2145	2145	2150	2150	2220	2270	2330
M350	3500	1500	1800	2000	2000	2500	3000	3500	3800	2245	2245	2250	2250	2320	2370	2430
M370	3700	1500	1800	2000	2000	2500	3000	3500	3800	2345	2345	2350	2350	2420	2470	2530
M400	4000	1500	1800	2000	2000	2500	3000	3500	3700	2545	2545	2550	2550	2620	2670	2730
M425	4250	1500	1800	1950	1950	2450	2850	3300	3550	2670	2670	2675	2675	2745	2795	2855
M450	4500	1450	1650	1750	1900	2300	2750	3150	3400	2795	2795	2800	2800	2870	2920	2980
M500	5000	1200	1400	1500	1800	2100	2400	2850	3000	3045	3045	3050	3050	3120	3170	3230
M550	5500	1000	1100	1300	1450	1500	2250	2350	2700	3345	3345	3350	3350	3420	3470	3530
M600	6000	800	900	900	1050	1150	1500	1650	2200	3595	3595	3600	3600	3670	3720	3780

Note: (1) \* refers to the rated load capacity of double-tyres for front wheels;  
(2) 2T (E) indicates that the model is CPD20-GE3LI-S/GE6LI-S;  
(3) When the front wheel of 2-2.5t truck is double-tyres (pneumatic tyre) and double tyre (solid tyre), the service weight is increased by 100kg and 220kg respectively.  
(4) When the front wheel of 3-3.5t truck is double-tyres (pneumatic tyre) and double tyre (solid tyre), the service weight is increased by 100kg and 180kg respectively.  
(5) When the front wheel of 3.8t truck is double-tyres (pneumatic tyre) and double tyre (solid tyre), the service weight is increased by 60kg and 190kg respectively.

Wide View Standard Mast (Tabulation2)

Mast model	Free lift (with backrest) (mm)							Service weight (kg)								Mast tilt angle α/β (°)		
	1.5-1.8t	2t(E)	2t	2.5t	3t	3.5t	3.8t	1.5t	1.8t	2t(E)	2t	2.5t	3t	3.5t	3.8t	1.5-1.8t	2t(E)	2-3.8t
M200	155	155	150	150	155	160	160	2886	3116	3216	3480	3870	4484	4894	5210	6/10	6/10	6/12
M250	155	155	150	150	155	160	160	2918	3148	3248	3525	3915	4532	4947	5255	6/10	6/10	6/12
M300	155	155	150	150	155	160	160	2950	3180	3280	3570	3960	4580	5000	5300	6/10	6/10	6/12
M330	155	155	150	150	155	160	160	2969	3199	3299	3597	3987	4609	5032	5330	6/10	6/10	6/12
M350	155	155	150	150	155	160	160	2982	3212	3312	3615	4005	4628	5053	5350	6/10	6/10	6/12
M370	155	155	150	150	155	160	160	2995	3225	3325	3633	4023	4647	5074	5367	6/6	6/6	6/6
M400	155	155	150	150	155	160	160	3043	3273	3373	3710	4100	4727	5158	5440	6/6	6/6	6/6
M425	155	155	150	150	155	160	160	3060	3290	3390	3733	4123	4751	5184	5462	6/6	6/6	6/6
M450	155	155	150	150	155	160	160	3076	3306	3406	3755	4145	4775	5211	5484	6/6	6/6	6/6
M500	155	155	150	150	155	160	160	3108	3338	3438	3800	4190	4823	5264	5530	6/6	6/6	6/6
M550	155	155	150	150	155	160	160	3170	3400	3500	3895	4285	4921	5368	5620	3/6	3/6	3/6
M600	155	155	150	150	155	160	160	3202	3432	3532	3940	4330	4969	5421	5666	3/6	3/6	3/6

Note: (1) \* refers to the rated load capacity of double-tyres for front wheels;  
(2) 2T (E) indicates that the model is CPD20-GE3LI-S/GE6LI-S;  
(3) When the front wheel of 2-2.5t truck is double-tyres (pneumatic tyre) and double tyre (solid tyre), the service weight is increased by 100kg and 220kg respectively.  
(4) When the front wheel of 3-3.5t truck is double-tyres (pneumatic tyre) and double tyre (solid tyre), the service weight is increased by 100kg and 180kg respectively.  
(5) When the front wheel of 3.8t truck is double-tyres (pneumatic tyre) and double tyre (solid tyre), the service weight is increased by 60kg and 190kg respectively.

Wide View Full Free 2-Stage Mast (Tabulation1)

Mast model	Max. lifting height(mm)	Load capacity (lode center 500mm)(kg)								Height (mast lowered)(mm)						
		1.5t	1.8t	2t(E)	2t	2.5t	3t	3.5t	3.8t	1.5-1.8t	2t(E)	2t	2.5t	3t	3.5t	3.8t
ZM200	2000	1500	1800	2000	2000	2500	3000	3500	3800	1495	1495	1500	1500	1570	1620	1680
ZM250	2500	1500	1800	2000	2000	2500	3000	3500	3800	1745	1745	1750	1750	1820	1870	1930
ZM300	3000	1500	1800	2000	2000	2500	3000	3500	3800	1995	1995	2000	2000	2070	2120	2180
ZM330	3300	1500	1800	2000	2000	2500	3000	3500	3800	2145	2145	2150	2150	2220	2270	2330
ZM350	3500	1500	1800	2000	2000	2500	3000	3500	3800	2245	2245	2250	2250	2320	2370	2430
ZM370	3700	1500	1800	2000	2000	2500	3000	3500	3800	2345	2345	2350	2350	2420	2470	2530
ZM400	4000	1500	1800	2000	2000	2500	3000	3500	3700	2545	2545	2550	2550	2620	2670	2730
ZM425	4250	1500	1800	—	1950	2450	2850	3300	—	2670	—	2675	2675	2745	2795	—
ZM450	4500	1450	1650	—	1900	2300	2750	3150	—	2795	—	2800	2800	2870	2920	—
ZM500	5000	1200	1400	—	1800	2100	2400	2850	—	3045	—	3050	3050	3120	3170	—
ZM550	5500	1000	1100	—	1450	1500	2250	2350	—	3345	—	3350	3350	3420	3470	—
ZM600	6000	800	900	—	1050	1150	1500	1650	—	3595	—	3600	3600	3670	3720	—

Note: (1) \* refers to the rated load capacity of double-tyres for front wheels;  
(2) 2T (E) indicates that the model is CPD20-GE3LI-S/GE6LI-S;  
(3) When the front wheel of 2-2.5t truck is double-tyres (pneumatic tyre) and double tyre (solid tyre), the service weight is increased by 100kg and 220kg respectively.  
(4) When the front wheel of 3-3.5t truck is double-tyres (pneumatic tyre) and double tyre (solid tyre), the service weight is increased by 100kg and 180kg respectively.  
(5) When the front wheel of 3.8t truck is double-tyres (pneumatic tyre) and double tyre (solid tyre), the service weight is increased by 60kg and 190kg respectively.

(6) 1-2T (E): the free lifting height increases by 379mm without backrest  
(7) 2-2.5t: the free lifting height increases by 356mm without backrest  
(8) 3t: the free lifting height increases by 520mm without backrest  
(9) 3.5t: the free lifting height increases by 426mm without backrest  
(10) 3.8t: the free lifting height increases by 426mm without backrest

Wide View Full Free 2-Stage Mast (Tabulation2)

Mast model	Free lift (with backrest) (mm)							Service weight (kg)								Mast tilt angle α/β (°)		
	1.5-1.8t	2t(E)	2t	2.5t	3t	3.5t	3.8t	1.5t	1.8t	2t(E)	2t	2.5t	3t	3.5t	3.8t	1.5-1.8t	2t(E)	2-3.8t
ZM200	485	485	496	496	340	443	503	2935	3165	3265	3492	3882	4505	4911	5263	6/10	6/10	6/12
ZM250	735	735	746	746	590	693	753	2967	3197	3297	3540	3930	4555	4964	5318	6/10	6/10	6/12
ZM300	985	985	996	996	840	943	1003	3001	3231	3331	3587	3977	4605	5018	5373	6/10	6/10	6/12
ZM330	1135	1135	1146	1146	990	1093	1153	3023	3253	3353	3617	4007	4637	5051	5406	6/10	6/10	6/12
ZM350	1235	1235	1246	1246	1090	1193	1253	3038	3268	3368	3635	4025	4657	5072	5428	6/10	6/10	6/12
ZM370	1335	1335	1346	1346	1190	1293	1353	3050	3280	3380	3655	4045	4677	5093	5450	6/6	6/6	6/6
ZM400	1535	1535	1546	1546	1390	1493	1553	3098	3328	3428	3731	4121	4755	5173	5520	6/6	6/6	6/6
ZM425	1660	—	1671	1671	1515	1618	—	3117	3347	—	3755	4145	4781	5200	—	6/6	—	—
ZM450	1785	—	1796	1796	1640	1743	—	3136	3366	—	3781	4171	4809	5229	—	6/6	—	—
ZM500	2035	—	2046	2046	1890	1993	—	3170	3400	—	3832	4222	4863	5285	—	6/6	—	—
ZM550	2335	—	2346	2346	2190	2293	—	3231	3461	—	3929	4319	4962	5388	—	3/6	—	—
ZM600	2585	—	2596	2596	2440	2543	—	3265	3495	—	3979	4369	5015	5444	—	3/6	—	—

Note: (1) \* refers to the rated load capacity of double-tyres for front wheels;  
(2) 2T (E) indicates that the model is CPD20-GE3LI-S/GE6LI-S;  
(3) When the front wheel of 2-2.5t truck is double-tyres (pneumatic tyre) and double tyre (solid tyre), the service weight is increased by 100kg and 220kg respectively.  
(4) When the front wheel of 3-3.5t truck is double-tyres (pneumatic tyre) and double tyre (solid tyre), the service weight is increased by 100kg and 180kg respectively.  
(5) When the front wheel of 3.8t truck is double-tyres (pneumatic tyre) and double tyre (solid tyre), the service weight is increased by 60kg and 190kg respectively.

(6) 1-2T (E): the free lifting height increases by 379mm without backrest  
(7) 2-2.5t: the free lifting height increases by 356mm without backrest  
(8) 3t: the free lifting height increases by 520mm without backrest  
(9) 3.5t: the free lifting height increases by 426mm without backrest  
(10) 3.8t: the free lifting height increases by 426mm without backrest

Wide View Full Free 3-Stage Mast (Tabulation1)

Mast model	Max. lifting height(mm)	Load capacity (lode center 500mm)(kg)								Height (mast lowered)(mm)						
		1.5t	1.8t	2t(E)	2t	2.5t	3t	3.5t	3.8t	1.5-1.8t	2t(E)	2t	2.5t	3t	3.5t	3.8t
ZSM360	3600	1500	1800	2000	2000	2500	3000	3500	3800	1790	1790	1800	1800	1870	1870	1930
ZSM400	4000	1500	1800	2000	2000	2500	3000	3500	3700	1925	1925	1950	1950	2020	2020	2055
ZSM435	4350	1450	1650	1850	1900	2400	2850	3200	3500	2040	2040	2050	2050	2120	2120	2180
ZSM450	4500	1450	1650	1750	1850	2300	2700	3050	3400	2090	2090	2100	2100	2170	2170	2230
ZSM470	4700	1400	1600	1650	1800	2200	2650	2900	3100	2160	2160	2165	2165	2230	2230	2295
ZSM480	4800	1350	1550	1650	1850	2250	2700	2950	3100	2190	2190	2210	2210	2270	2270	2330
ZSM500	5000	1200	1400	1500	1800	2100	2450	2800	3000	2290	2290	2300	2300	2370	2370	2430
ZSM540	5400	1000	1100	1300	1450	1500	2250	2350	2700	2415	2415	2400	2400	2470	2470	2555
ZSM600	6000	800	900	900	1050	1100	1400	1650	2200	2640	2640	2600	2600	2670	2670	2780
ZSM650	6500	1100	1250	—	1450	1650	2000	2200	—	2840	—</					



Lithium battery (Tabulation1)								
Battery brand	CATL							
Voltage/Capacity	80V/150Ah	80V/202Ah	80V/271Ah	80V/346Ah	80V/404Ah	80V/456Ah	80V/542Ah	80V/604Ah
1.5-1.8-2t(E)S	○	○	○	—	—	—	—	—
1.5-1.8t M	—	●	○	—	—	—	—	—
1.5-1.8t H	—	●	○	—	—	—	—	—
2-2.5t S	—	○	○	○	○	○	—	—
2-2.5t M	—	—	●	○	○	○	—	—
2-2.5t H	—	—	●	○	○	○	—	—
3-3.5t S	—	—	○	○	○	○	○	○
3-3.5t M	—	—	—	○	●	○	○	○
3-3.5t H	—	—	—	○	●	○	○	○
3.8t S	—	—	○	○	○	○	○	○
3.8t M	—	—	—	●	○	○	○	○
Heating at low Temperature	●							

Lithium battery (Tabulation2)										
Battery brand	HELI					EIKTO				
Voltage/Capacity	80V/150Ah	80V/202Ah	80V/272Ah	80V/404Ah	80V/544Ah	80V/150Ah	80V/220Ah	80V/270Ah	80V/300Ah	80V/350Ah
1.5-1.8-2t(E)S	●	○	○	—	—	○	○	○	—	—
1.5-1.8t M	—	○	○	—	—	—	—	—	—	—
1.5-1.8t H	—	○	○	—	—	—	—	—	—	—
2-2.5t S	—	●	○	○	—	—	○	—	○	○
2-2.5t M	—	—	○	○	—	—	—	—	—	—
2-2.5t H	—	—	○	○	—	—	—	—	—	—
3-3.5t S	—	—	●	○	○	—	—	—	○	○
3-3.5t M	—	—	—	○	○	—	—	—	—	—
3-3.5t H	—	—	—	○	○	—	—	—	—	—
3.8t S	—	—	●	○	○	—	—	—	○	○
3.8t M	—	—	—	○	○	—	—	—	—	—
Heating at low Temperature	●									

Charger			
Model		D80V200ALi-123 D80V200ALi-423	D80V-100A-Li-123 D80V-100A-Li-423
Applied battery type		48/80V lithium battery recommendation: capacity higher than 240Ah	
Wiring type		Three-phase four-wiring type	
Power of charger	KVA	22	10
Air switch model of Upper level power	A	63	32
Input voltage range	Vac	380±15%	
Input current	A	<40	<20
Output current	A	0~200	0~100
Protection level		(For indoor use)	
Working ambient temperature	°C	-20~+45	
Plugs and sockets		Charger meeting national standard	
Charger		Full charging time=required charging capacity/charging current+0.2h For example: the battery capacity is 80V/404Ah, and the discharging state is alarmed by instrument, The charger is 200A, thus the full charging time is 404*0.9/200+0.2≈2h	

Optional				
Model		S	M	H
Safety	Steering automatic deceleration	●	●	●
	Reversing handle with horn button	●	●	●
	Over speed alarm (5km/h)	○	○	○
	Over speed alarm (8km/h)	○	○	○
	Over speed alarm (10km/h)	○	○	○
	OPS (excluding descent)	●	●	○
	OPS	○	○	●
	Seat switch	○	○	○
	Multi way valve overload	●	●	●
	Dry-powder fire extinguisher (0.5kg)	○	○	○
	Dry-powder fire extinguisher (2kg)	○	○	○
	Backward buzzer	●	●	●
	Reversing chinese language speaker	○	○	○
	Electronic upper buffer	—	○	○
	Rearview mirror with angle in the middle	●	●	●
	Left and right rearview mirror+rearview mirror with angle in the middle	○	○	○
Reversing radar (4 probes)	○	○	○	
Reversing image (1 camera +4 probes)	○	○	○	
Comfort	Semi-enclosed seat	●	●	●
	Suspension seat	○	○	○
	USB	●	●	●
	Steer activated by steering wheel	●	●	●
	Mechanical valve	●	●	●
	Electro-magnetic valve(proportion valve+thumb switch)	—	○*	○*
Optional overhead guard	Fan	○	○	○
	Height of overhead guard 50mm increased	○	○	○
Cab/Windshield	Overhead guard with protection net	○	○	○
	Panel-mounted cab (with fan +windshield wiper)	○	○	○
	With heater	○	○	○
	With cooling air conditioner (rear installed type)	○	○	○
	With cooling air conditioner (rear installed type) +heater	○	○	○
	With front windshield glass (with wiper/without shower)	○	○	○
	With rear windshield glass	○	○	○
	With top rainshield glass (without fan)	○	○	○
Lights	LED rear working light	○	○	○
	Rear LED red/blue spot light	○	○	○
	Three sides (left, right and rear) red/blue bar light	○	○	○
	Fixed LED flickering warning light	●	●	●
	Fixed LED rotating warning light	○	○	○
	Fixed LED rotating and buzzer alarm light	○	○	○
Others	Single tyre (front wheel)	●	●	●
	Dual tyres (front wheel)	○	○	○
	Metric thread	●	●	●
	American thread	○	○	○
	Sleeve for tilting cylinder	●	●	●
	Sleeve for tilting cylinder and steering cylinder	○	○	○
FCIS standard type (for China)	●	●	●	

Note: "●" standard ; "○" optional ; "—" non-configurable ; "\*" only ZAPI controller